



FF3262

Arm with 7 mounting points (5/8")

The Arm is used to suspend up to 6 lighting fixtures from a single pantograph or drop arm.

 material: steel

 finish: grey powder coating with orange peel finish RAL 7016

 weight: 1,194 kg
2,632 lb

 volume: 0,0070 cu m
0,2472 cu ft

 max. load: 80 kg
176 lb

 weight: 1,694 kg
3,734 lb

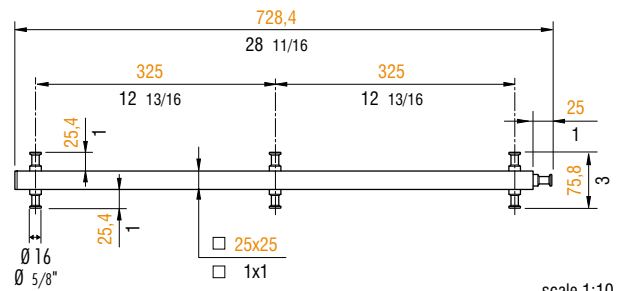

scale 1:10

APPLICATIONS

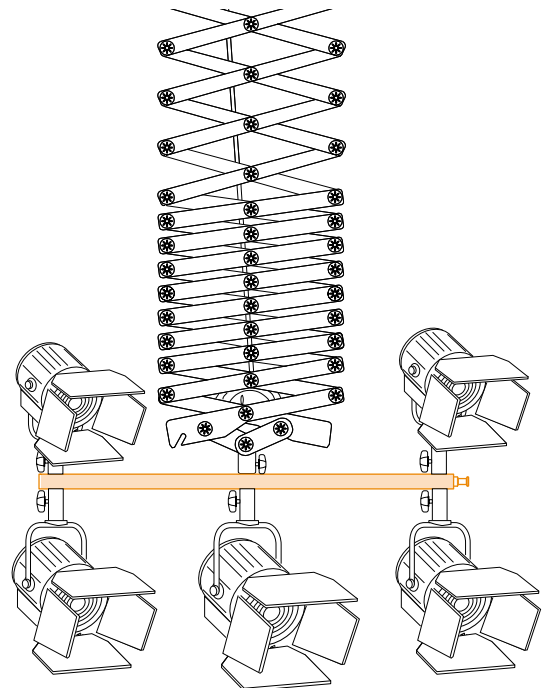
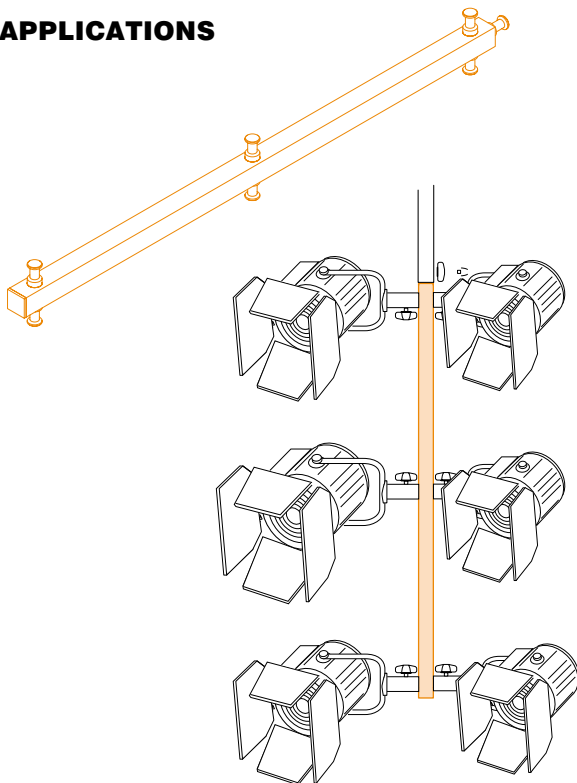

Metric measurements should be taken as reference. Imperial values have been calculated from metric and rounded to nearest 1/32 inch. 
IMPORTANT: installation must be carried out by qualified personnel and in accordance with the safety regulations of the country/region of installation.